



FAMIGLIA

ZONIN

DAL 1821

VALPOLICELLA
RIPASSO

DENOMINAZIONE DI ORIGINE CONTROLLATA

SUPERIORE

DATI TECNICI	
FORMATO	105,6x107
CODICE	45004972
N. BOZZA	M15260R01
DATA	25/05/2017

IDENTIFICAZIONE MATERIALE	
FRONTALE	RUSTIQUE BLANC
ADESIVO	S2030
LINER	PET30
PLASTIFICAZIONE	
CODICE	
FORNITORE	FASSON
VERNICE	

SEQUENZA COLORI
 Vernice Braille Lucida
<input type="checkbox"/>
<input type="checkbox"/>
<input type="checkbox"/>
<input type="checkbox"/>
<input type="checkbox"/>
<input type="checkbox"/>
<input type="checkbox"/>
<input type="checkbox"/>
<input checked="" type="checkbox"/> FUSTELLA



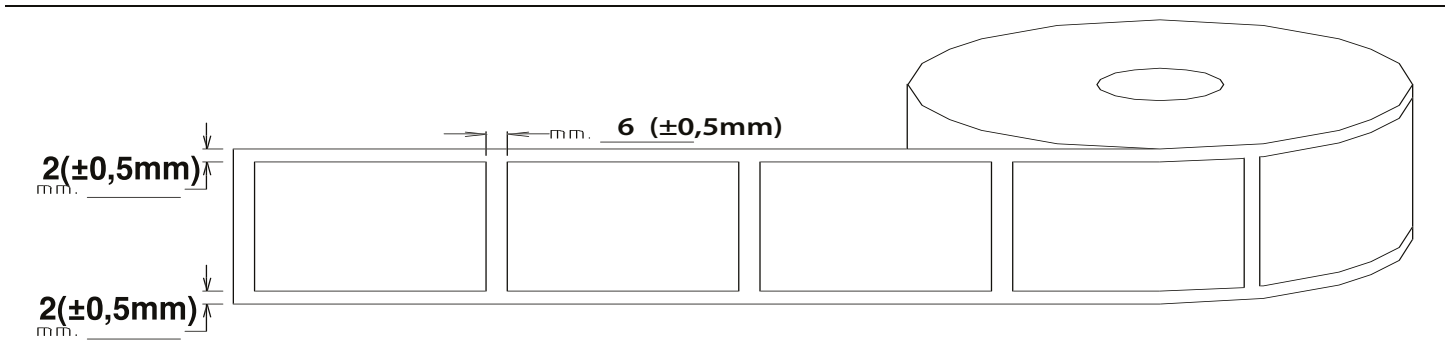
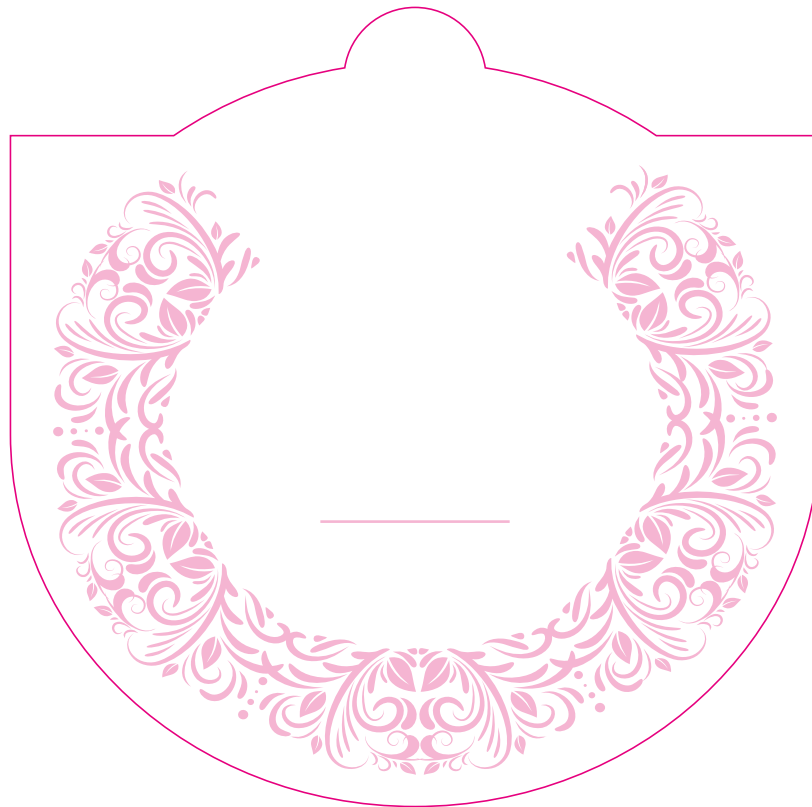

ATTENZIONE: Per poter procedere alla stampa compilare in ogni sua parte il presente schema.

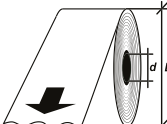

DATI DI CONFEZIONAMENTO

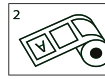
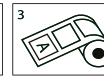
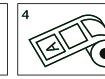
 **Nuceria group**
 Via Benaco, 2 - 20098 San Giuliano Mil.se (MI) - Italia
 Tel. (+39) 02 98245608 Fax (+39) 02 98492074
www.nuceriadesivi.com

SVOLGIMENTO N.: 01
 Etichette per bobina= _____

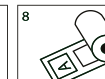
 D= 350mm
 d= 76mm

APPROVAZIONE BOZZA
 Apporre qui Data, Timbro e Firma per procedere alla stampa

Il Cliente **OK** visto si stampi

CLIENTE: ZONIN

DESCRIZIONE ET_FR_VALPOLICELLA_DOC_SUPERIORE_RIPASSO_750ML

Mod. 41B

DATI TECNICI	
FORMATO	105,6x107
CODICE	45004972
N. BOZZA	M15260R01
DATA	25/05/2017

IDENTIFICAZIONE MATERIALE	
FRONTALE	RUSTIQUE BLANC
ADESIVO	S2030
LINER	PET30
PLASTIFICAZIONE	
CODICE	
FORNITORE	FASSON
VERNICE	

SEQUENZA COLORI	
	Embossing
<input type="checkbox"/>	
<input type="checkbox"/>	
<input type="checkbox"/>	
<input type="checkbox"/>	
<input type="checkbox"/>	
<input type="checkbox"/>	
<input type="checkbox"/>	
	FUSTELLA

ATTENZIONE: Per poter procedere alla stampa compilare in ogni sua parte il presente schema.

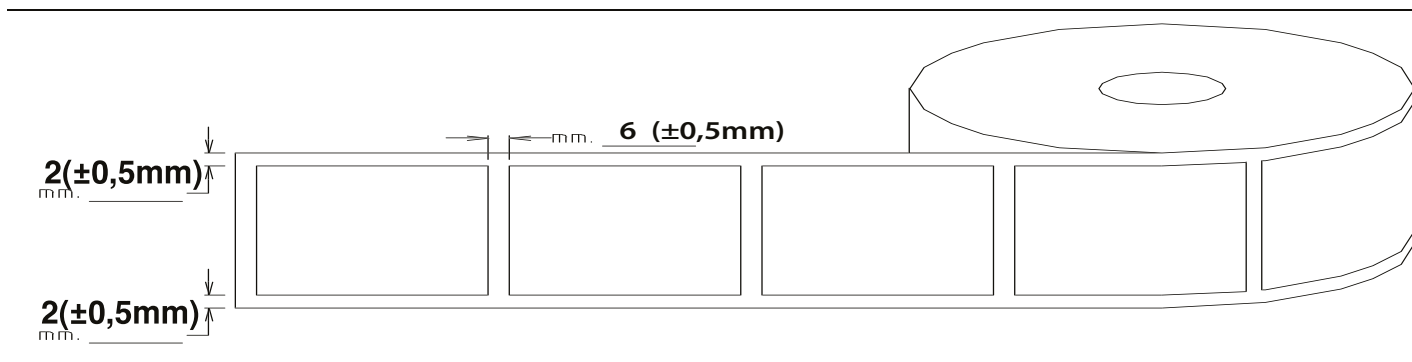

DATI DI CONFEZIONAMENTO



Nuceria group
Via Benaco, 2 - 20098
San Giuliano Mil.se (MI) - Italia
Tel. (+39) 02 98245608
Fax (+39) 02 98492074
www.nuceriadesivi.com

SVOLGIMENTO N.:01
Etichette per bobina= _____

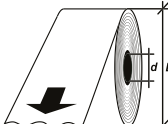

D= 350mm
d= 76mm

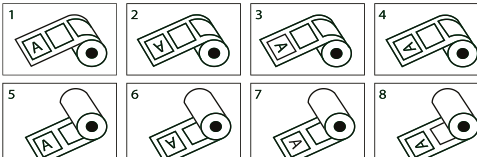

APPROVAZIONE BOZZA
Apporre qui Data, Timbro e Firma per procedere alla stampa

Il Cliente **OK** visto si stampi